

# XINJE

## **OP** operate panel

**User manual**

Xinje Electric Co., Ltd.

Data No. HOC01 20110705 8.0

## **Basic instructions**

- Thanks for buying OP series operate panel.
- This manual will introduce the hardware features and wiring of OP.
- Please read the manual carefully before wiring.
- For OP software, please refer to OP software manual.
- Please pass the manual to the final user.

## **User notes**

- Only the operator who has electrical knowledge can use the OP. Please consult us if there is anything unclear.
- The examples in the manual are only for reference, we are not sure they can work.
- Please confirm the product is accord with related specifications when use with other products.
- Please confirm the product is accord with safety requirements when using. Please set the safety function for the machine.

## **Responsibility**

- We can not ensure the manual contents are accord with the product totally though we have checked the manual carefully.
- We are glad to accept customers' advice. We will often check the manual contents and modify them in the next version.
- Please note that we will not inform customers if the manual has been modified.

## **Contact us**

- Telephone: +86-0510-85134136
- Fax: +86-0510-85111290
- Address: 4<sup>th</sup> floor, building 7, originality industrial city, JiangSu province, Wuxi, China
- Post code: 214072

**Xinje Electronic Co., Ltd. All rights reserved**

Without written permission, copy, transfer or use the contents in the manual are forbidden.

**July, 2011**

# Catalog

<b>1 HARDWARE .....</b>	<b>3</b>
1-1. INTRODUCTION.....	3
1-2. GENERAL SPECIFICATIONS.....	3
1-3. FUNCTION SPECIFICATIONS.....	4
1-3-1. OP320/OP320-S .....	4
1-3-2. OP320-A/OP320-A-N/OP320-A-S .....	4
1-3-3. OP325-A/OP325-A-S.....	5
1-3-4. OP330/OP330-S .....	5
1-4. PART .....	6
1-5. BUTTON FUNCTION.....	7
1-6. PORT AND DOWNLOAD CONNECTION.....	8
1-6-1. Port .....	8
1-6-2. Download connection.....	8
1-7. DIMENSION AND INSTALLATION .....	9
1-7-1. Dimension.....	9
1-7-2. Installation .....	10
<b>2 Q&amp;A .....</b>	<b>11</b>
2-1. CANNOT DOWNLOAD PROGRAM.....	11
2-2. COMMUNICATION PROBLEM ABOUT OP AND PLC .....	11
2-3. PROGRAM SECURITY .....	12
2-4. INTERACTIVE CONTROL.....	12
2-5. SET DATA IN SEQUENCE .....	13
2-6. OTHERS .....	13
<b>3 PLC CONNECTION .....</b>	<b>14</b>
3-1. XINJE XC SERIES PLC.....	14
3-1-1. Connection unit .....	14
3-1-2. Communication parameter .....	14
3-1-3. Cable connection .....	15
3-2. MITSUBISHI FX SERIES PLC.....	17
3-2-1. Connection unit .....	17
3-2-2. Communication parameters.....	17
3-2-3. Cable connection .....	18
3-3. SIEMENS S7-200 SERIES PLC .....	19
3-3-1. Connection unit .....	19
3-3-2. Communication parameters.....	19
3-3-3. Cable connection .....	20
3-4. OMRON C SERIES PLC.....	20
3-4-1. Connection unit .....	20
3-4-2. Communication parameters.....	21
3-4-3. Cable connection .....	22

3-5. KOYO S SERIES PLC .....	23
3-5-1. Connection unit .....	23
3-5-2. Communication parameters .....	24
3-5-3. Cable connection .....	25
3-6. DELTA DVP SERIES PLC .....	26
3-6-1. Connection unit .....	26
3-6-2. Communication parameters .....	26
3-6-3. Cable connection .....	27
3-7. LG MASTER-K (PROGRAMMING PORT) SERIES PLC .....	27
3-7-1. Connection unit .....	28
3-7-2. Communication parameters .....	28
3-7-3. Cable connection .....	29
3-8. LG MASTER-K (MODBUS) SERIES PLC (MULTI-FUNCTION PORT) .....	29
3-8-1. Connection unit .....	29
3-8-2. Communication parameters .....	29
3-8-3. Cable connection .....	30
3-9. LG MASTER-K (CNET) SERIES PLC (MULTI-FUNCTION PORT) .....	31
3-9-1. Connection unit .....	31
3-9-2. Communication parameters .....	31
3-9-3. Cable connection .....	33
3-10. MATSUSHITA FP SERIES PLC .....	34
3-10-1. Connection unit .....	34
3-10-2. Communication parameters .....	34
3-10-3. Cable connection .....	35
3-11. SCHNEIDER NEZA SERIES PLC .....	37
3-11-1. Connection unit .....	37
3-11-2. Communication parameters .....	37
3-11-3. Cable connection .....	39
3-12. FATEK FB SERIES PLC .....	39
3-12-1. Connection unit .....	39
3-12-2. Communication parameters .....	40
3-12-3. Cable connection .....	40
3-13. VIGOR VB SERIES PLC .....	42
3-13-1. Connection unit .....	42
3-13-2. Communication parameters .....	43
3-13-3. Cable connection .....	43
3-14. EMERSON EC20 SERIES PLC .....	44
3-14-1. Connected unit .....	44
3-14-2. Communication parameters .....	45
3-14-3. Cable connection .....	45
3-15. IDEC MICRO SMART SERIES PLC .....	46
3-16. KEYENCE KV SERIES PLC .....	47
3-17. SAIA-BURGESS PCD SERIES PLC .....	48

# 1 Hardware

## 1-1. Introduction

OP series operate panel can control the PLC through buttons, texts, lamps.

Characteristics:

- Edit the program in OP20 software, download program via PC serial port
- Can communicate with various PLCs. Such as Mitsubishi FX series, Omron C series, Siemens S7 series, Koyo SG series and so on
- Password function
- Built-in RTC
- OP can display dynamic text
- Alarm function
- All the buttons can be defined as multi-function
- STN LCD with backlight
- Protection level is up to IP65
- Support bmp picture displaying

## 1-2. General specifications

### 1. Electrical spec

Input voltage	DC24V
Input voltage range	DC20V-DC28V
Power	< 4W(TYPE2.0W)
Power-off permission	< 20ms
Voltage endurance	AC1000V-10MA 1minute (signal and ground)
Insulated resistance	DC500V- about 10MΩ (signal and ground)

### 2. Environment

Operate temperature	0~50℃, no condensation
Storage temperature	-20~60℃
Humidity	20~85% (no condensation)
Vibration endurance	10~25Hz(X, Y, Z direction 30 minutes 2G)
Noise immunity	Voltage noise: 1000Vp-p, pulse width is 1
Air	No corrosive gas
Protection	IP65 for front cover
Cooling method	Natural cooling

### 1-3. Function specifications

OP series:

Type	Button	LCD	Backlight	Port	Dimension (mm)	Mounting dimension (mm)
OP320	7	3.7"	STN LCD	RS232/RS422	162.0×102.0×38.0	156.5×94.0
OP320-S				RS232/RS485		
OP320-A	20			RS232/RS422	172.0×94.0×30.0	163.0×85.0
OP320-A-N				RS232		
OP320-A-S				RS232/RS485		
OP325-A				RS232/RS422		
OP325-A-S	RS232/RS485			172.0×94.0×38.3	164.2×86.8	
OP330	26			3.7"	STN LCD	RS232/RS422
OP330-S		RS232/RS485				

#### 1-3-1. OP320/OP320-S

Display	Type	Blue LCD
	Use life	Above 20000 hours, temperature 25℃, 24-hour running
	Display area	192*64
	Brightness	Adjust by potentiometer
	Text	English (24 words×4 rows)
	Font	Lattice, vector
	Button	7
Memory	Program	64KB FalshROM
	Data	1KB SRAM
Port	Download	RS232
	communication	OP320: RS232/RS422
		OP320-S: RS232/RS485

#### 1-3-2. OP320-A/OP320-A-N/OP320-A-S

Display	Type	Blue LCD
	Use life	Above 20000 hours, temperature 25℃, 24-hour running
	Display area	192*64
	Brightness	Adjust by potentiometer
	Text	English (24 words×4 rows)
	Font	Lattice, vector
	Button	20
Memory	Program	64KB FalshROM
	Data	1KB SRAM
Port	Download	RS232
	communication	OP320-A: RS232/RS422
		OP320-A-N: RS232
		OP320-S: RS232/RS485

### 1-3-3. OP325-A/OP325-A-S

Display	Type	Blue LCD
	Use life	Above 20000 hours, temperature 25℃, 24-hour running
	Display area	192*64
	Brightness	Adjust by potentiometer
	Text	English (24 words×4 rows)
	Font	Lattice, vector
	Button	20
Memory	Program	64KB FalshROM
	Data	1KB SRAM
Port	Download	RS232
	communication	OP325-A: RS232/RS422
		OP325-A-S: RS232/RS485

### 1-3-4. OP330/OP330-S

Display	Type	Blue LCD
	Use life	Above 20000 hours, temperature 25℃, 24-hour running
	Display area	192*64
	Brightness	Adjust by potentiometer
	Text	English (24 words×4 rows)
	Font	Lattice, vector
	Button	7
Memory	Program	64KB FalshROM
	Data	1KB SRAM
Port	Download	RS232
	communication	OP330: RS232/RS422
		OP330-S: RS232/RS485

## 1-4. Part

Take OP320-A for example:

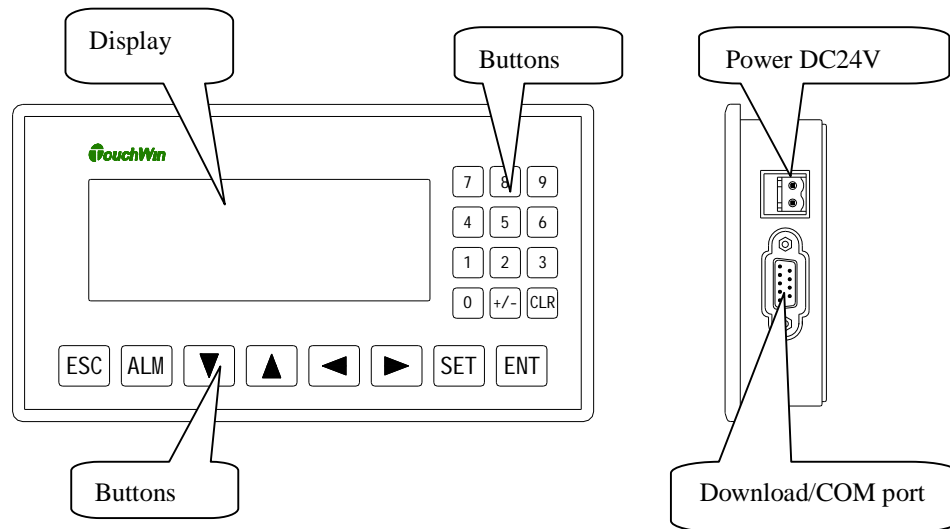

Note:













- (1) There is a potentiometer at the reverse side of OP cover. It can adjust the LCD brightness. Please rotate it with the screw. The LCD backlight will be OFF if there are no any operations for 3 minutes.
- (2) The diagram is only for your reference, each type please see the real product.

## 1-5. Button function

The buttons on the OP panel can be defined as many functions. They can instead of the buttons on the control machine which has long using life and better touch feeling.

Besides, these buttons can be defined to special function such as set on /off bit, screen jump. If no need special functions, the buttons will execute basic functions: set the value of register, reset original screen, page up/down.

Buttons functions:

Button	Basic function
	Return to the original screen (default is screen no.1). The main menu or frequenct-used screen can be set to original screen
	
	Left shift data bit when changing the register
	Right shift data bit when changing the register
	Page down, the default value = current page -1. Minus one for the data being changed, the range is 0 -> 9 -> 0
	Page up, the default value = current page +1. Plus one for the data being changed, the range is 9 -> 0 -> 9
	Press this button to change the register value, the changed bit is shining. If there is no register in the program, this button executes do-nothing operation. Press this button before pressing ENT to cancel the current modification and continue to change the next register.
	Confirm the modification and continue the next one
	After setting alarm list function, press this button to enter alarm screen Used as function button
	Clear the register value Used as function button
	Set the negative or positive of value Used as function button
	Numeric button (range: 0~9) Used as function button
	Overall function button or normal function button

## 1-6. Port and download connection

### 1-6-1. Port

OP series has a DB9 port. It can download program and communicate with other devices.

OP320, OP320-A, OP325-A, OP330		OP320-A-N		OP320-S, OP320-A-S, OP325-A-S, OP330-S	
Pin	Name	Pin	Name	Pin	Name
1	TD+			1	TD+
2	RXD	2	RXD	2	RXD
3	TXD	3	TXD	3	TXD
4		4		4	
5	GND	5	GND	5	GND
6	TD-	6		6	TD-
7		7		7	
8	RD-	8		8	B
9	RD+	9		9	A

### 1-6-2. Download connection

Please use OP cable to connect OP 9-pin port and PC serial port. The cable can be also used to connect OP and PLC.

#### OP and PC connection diagram:

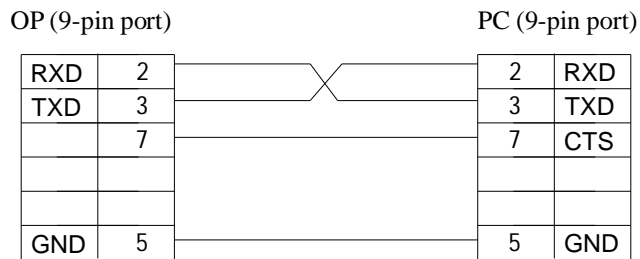

## 1-7. Dimension and installation

### 1-7-1. Dimension

Unit: mm

#### ■ OP320, OP320-S

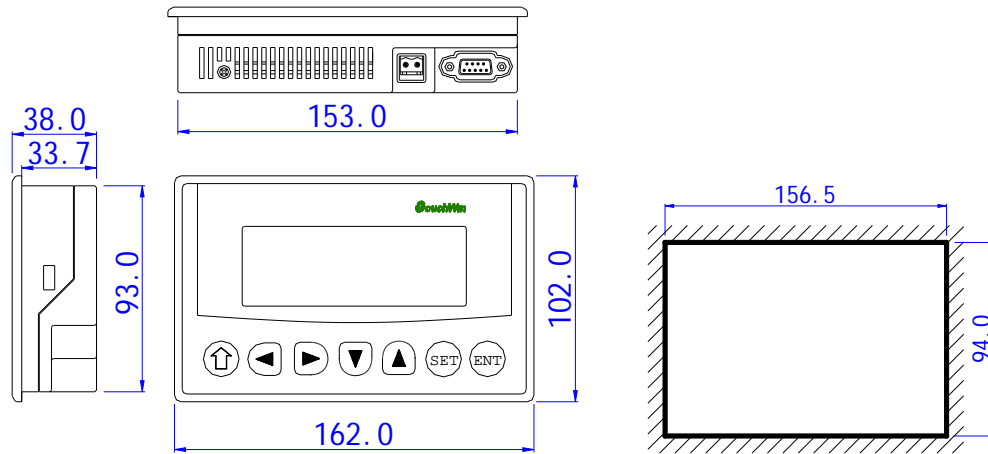

#### ■ OP320-A, OP320-A-N, OP320-A-S

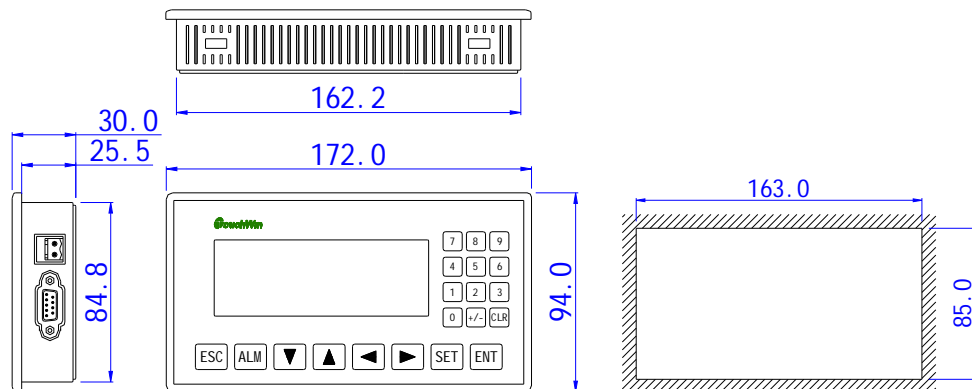

#### ■ OP325-A, OP325-A-S

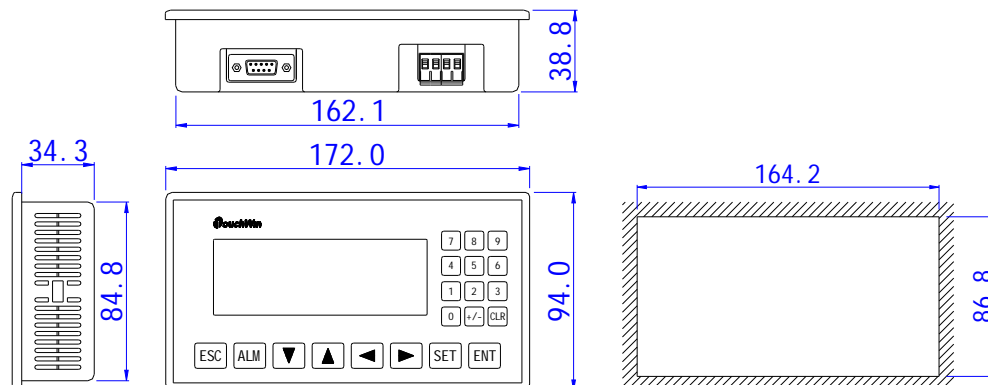

■ OP330, OP330-S

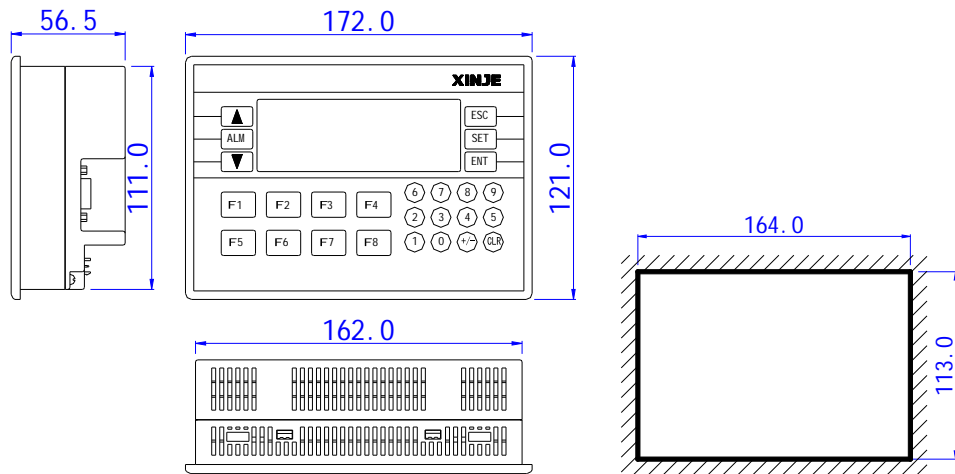

**1-7-2. Installation**

OP installation diagram:

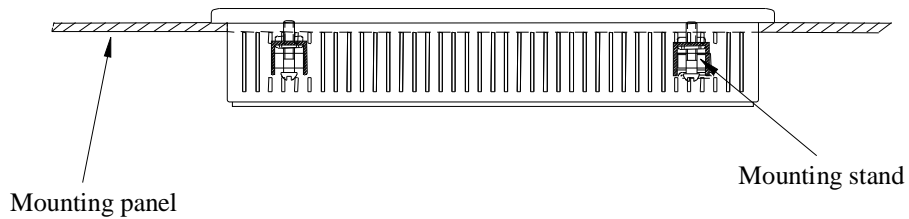

Mounting steps:

- (1) Make a mounting hole on the mounting panel
- (2) Put the bottom of OP into the hole
- (3) Mount the mounting stand into the fixing hole
- (4) Tighten the 4 screws in the fixing hole

Note:

1. Make sure the mounting hole will not hurt the OP surface. Please leave some space between hole and OP.
2. Don't make the screw too tight to avoid cover damage.
3. Please add seal ring in the hole



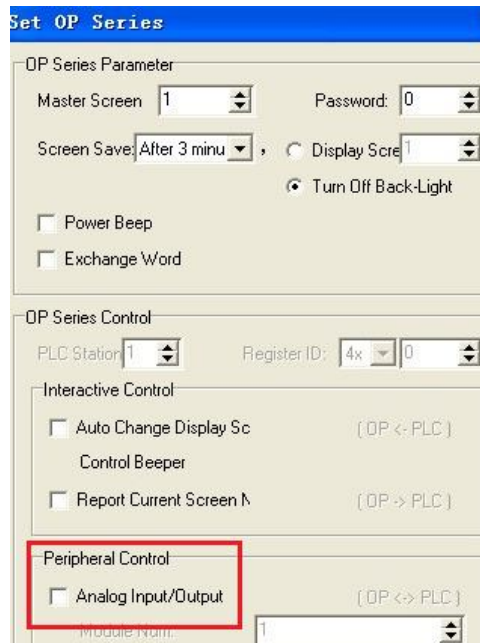

5. Contact us if they still cannot communicate.

### 2-3. Program security

OP program cannot be uploaded for security reason.

### 2-4. Interactive control

Please choose “auto change display Screen” and set register address in Tool/Set OP series...

Set the register to n, OP will jump to screen No.n when power on. Then the register value will be cleared.

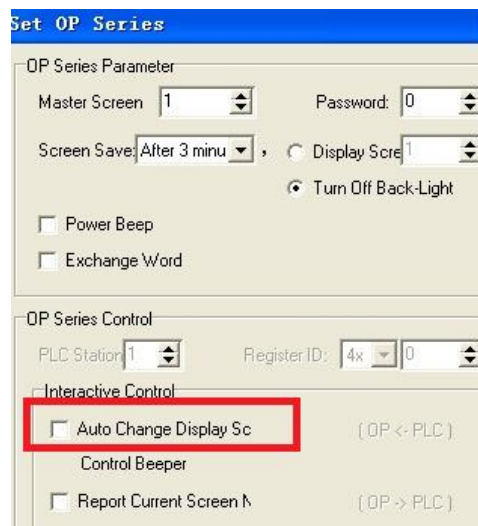

## **2-5. Set data in sequence**

If there are many values need to set in one screen, please click each of them in sequence before downloading. Then you can set these values in sequence.

## **2-6. Others**

1. When choosing Modbus or free format protocol, OP20 will have register 4x, 3x, 1x, 0x.  
1x and 3x mean read only.  
0x and 4x mean read and write.
2. OP320/OP320-A/OP325/OP330 cannot support RS485.

# 3 PLC connection

This chapter will introduce the connection method of OP and PLC.

The communication steps of PLC and OP:

1. Choose the PLC type communicating with OP. Check if the communication parameters of OP and PLC are the same. The station no. of each part in the OP program should be same to PLC.
2. Please disconnect the OP cable with PC after finish the downloading.
3. Connect OP and PLC with PLC cable, power on them, OP starts to work.

## 3-1. Xinje XC series PLC

### 3-1-1. Connection unit

Series	CPU	Connected module	Port	Cable	Choose PLC type in OP20
XC	XC1 XC2 XC3 XC5 XCM XCC	CPU	RS232	Diagram 1	Xinje XC series
			RS485	Diagram 2	

### 3-1-2. Communication parameter

OP software default settings:

Parameter	Recommend Settings	Choices of settings	Note
PLC model	XC series	FC/XC series	Choose correct PLC model communicating with OP
Port	RS232	RS232/RS485	
Data bit	8	7/8	Accord with PLC port settings
Stop bit	1	1/2	Accord with PLC port settings
Parity	Even parity	Even /odd/no parity	Accord with PLC port settings
Baud rate	19200	4800/38400/9600/115200 /19200/187500	Accord with PLC port settings
Station no.	1	0~255	

Default communication parameters of Xinje XC series PLC: 19200, 8, 1, even parity, station no.1.

**PLC software settings:**

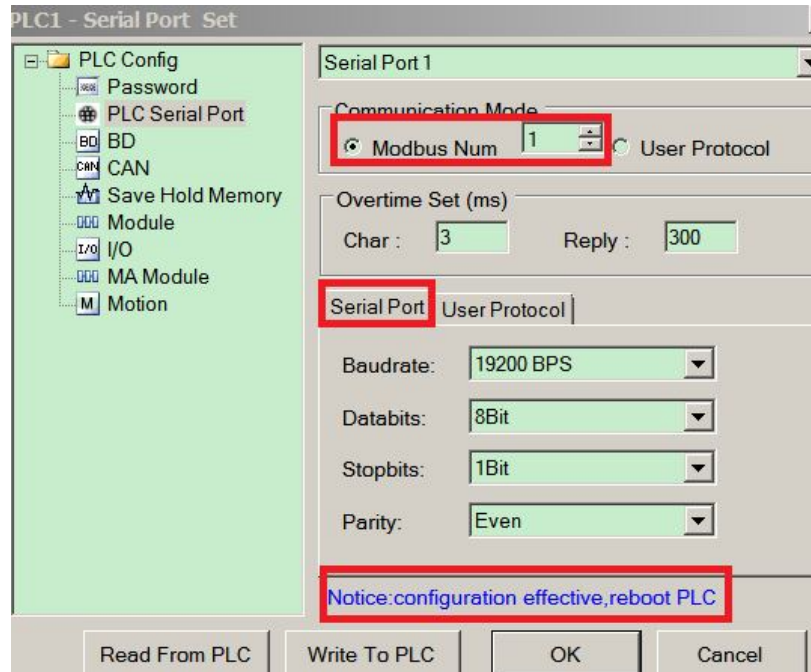

**3-1-3. Cable connection**

**1. Direct connect to XC series PLC CPU (RS232 port)**

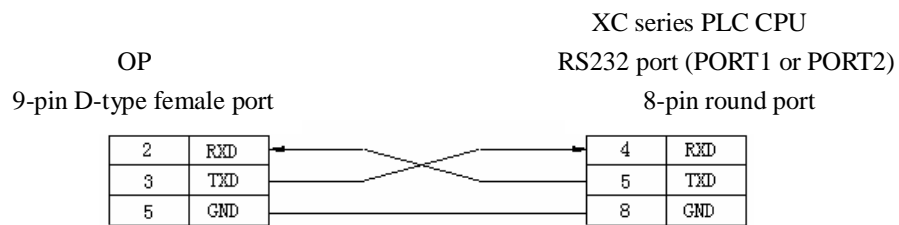

(Diagram 1: fit for OP all series)

PLC port:

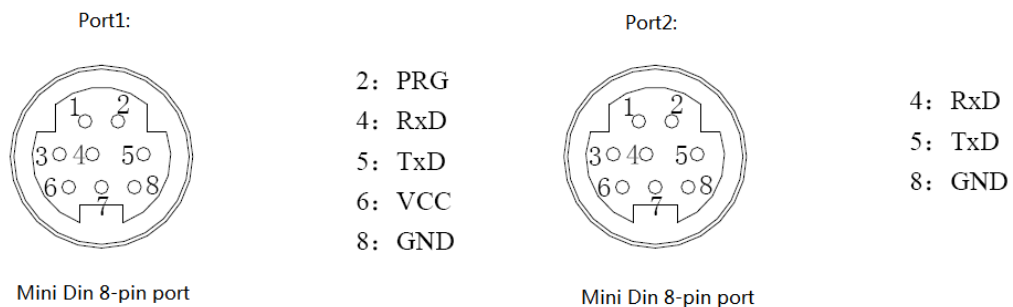

**2. Direct connect to XC series PLC CPU (RS485 port)**

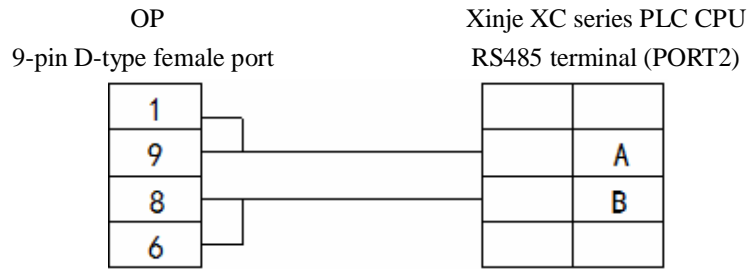

(Diagram 2— fit for OP320-S, OP320-A-S, OP325-S, OP330-S)

**3. Connect PLC via XC-COM-BD (RS232)**

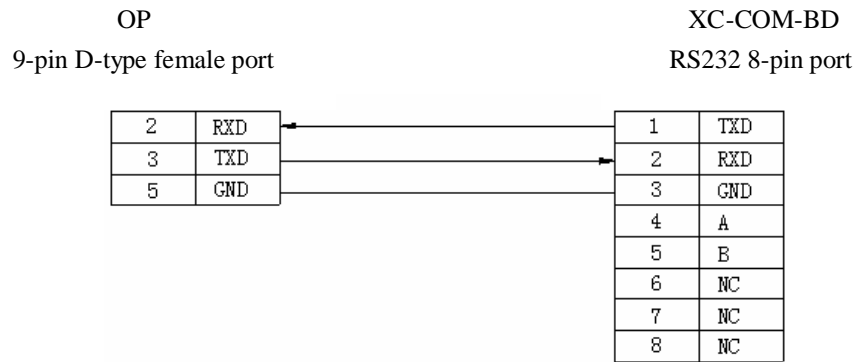

(Diagram 3— fit for OP all series)

**4. Connect PLC via XC-COM-BD (RS485)**

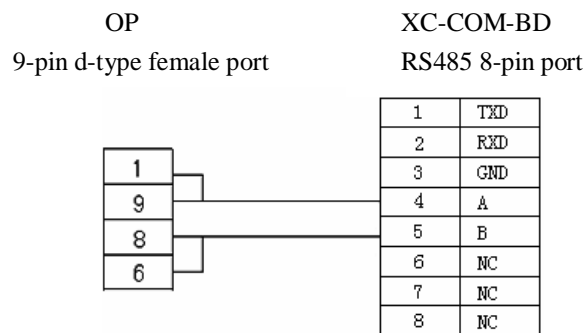

(Diagram 4— fit for OP320-S, OP320-A-S, OP325-S, OP330-S)

### 3-2. Mitsubishi FX series PLC

#### 3-2-1. Connection unit

Series	CPU	Connected module	Port	Cable	Choose PLC type in OP20
FX	FX0N FX1N FX2N FX1S FX3U	CPU	RS422	Diagram 1	Mitsubishi FX series PLC
	FX3G FX0 FX1	CPU	RS422	Diagram 1	Mitsubishi FX series PLC
	FX2	CPU	RS422	Diagram 2	Mitsubishi FX series PLC

#### 3-2-2. Communication parameters

##### OP default settings

Series	Recommend settings	Choices of settings	Note
PLC type	FX series		Choose correct PLC model communicating with OP
Data bit	7	7/8	Accord with PLC port settings
Stop bit	1	1/2	Accord with PLC port settings
Parity	Even parity	Even /odd/no parity	Accord with PLC port settings
Baud rate	9600	4800/9600/19200/38400/5600 /57600/115200/187500	Accord with PLC port settings
Station no.	0	0~255	

The default parameters of Mitsubishi FX series PLC: 9600, 7, 1, even parity, station no. 0

**PLC software settings:**

**FX parameter**

Memory capacity | PLC name | I/O assignment | PLC system(1) | PLC system(2)

Operate communication setting

If the box is not checked, the parameters will be cleared.  
(When the program is transferred to the communication board, parameters and D8120 values in the PLC must be cleared upon program transfer.)

Protocol Non-procedural	<input type="checkbox"/> Control line
Data length 7bit	H/W type Regular/RS-232C
Parity Even	Control mode Invalid
Stop bit 1bit	<input type="checkbox"/> Sum check
Transmission speed 9600 (bps)	Transmission control procedure Form1

**3-2-3. Cable connection**

**1. FX1N/2N/3U/3G/1S series PLC (RS422)**

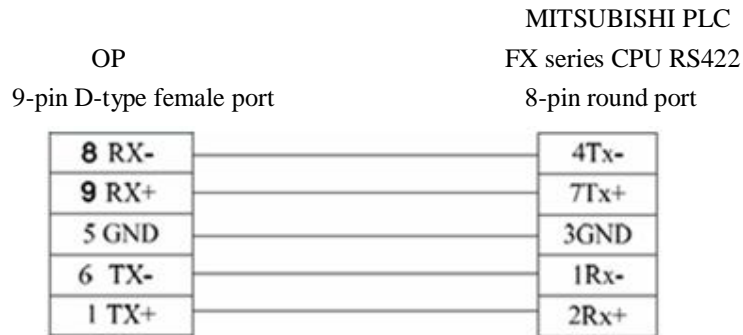

(Diagram 1— fit for OP320, OP320-A, OP325, OP330)

## 2. FX2 series PLC

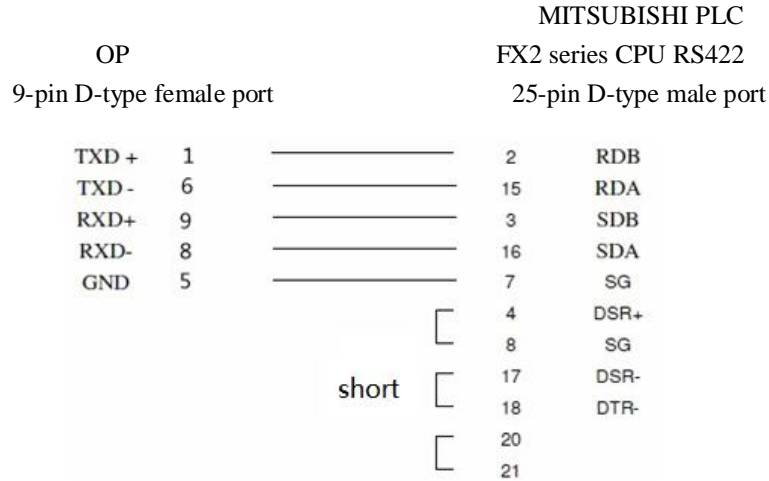

(Diagram 2— fit for OP320, OP320-A, OP325, OP330)

## 3-3. Siemens S7-200 series PLC

### 3-3-1. Connection unit

OP series can communicate with S7-200 series PLC (PPI protocol) via programming port or expansion port.

Series	CPU	Connected module	Port	Cable	Choose PLC type in OP20
S7-200	CPU212 CPU221 CPU222 CPU224 CPU226	CPU	<b>RS485</b>	Diagram 1	Siemens S7-200 series PLC

### 3-3-2. Communication parameters

#### OP software settings

Parameters	Recommend settings	Choices of settings	Note
PLC type	S7-200		Choose correct PLC type when communicating with OP
Port	RS485	RS485	
Data bit	8	7/8	Accord with PLC port parameters
Stop bit	1	1/2	Accord with PLC port parameters
Parity	Even parity	Even /odd /no parity	Accord with PLC port parameters
Baud rate	9600	4800/38400/9600/115200	Accord with PLC port

		/19200/187500	parameters
Station no.	2		<b>Must use recommend settings</b>

The default parameters of Siemens S7-200 series PLC: 9600, 8, 1, even parity, station no.2

**PLC software settings:**

**S7-200 communication notes:**

1. Siemens PLC register has VB(8-bit), VW(16-bit), VD(32-bit).
2. The register address is overlapped. VW address should be the times of 2; VD address should be the times of 4.

**3-3-3. Cable connection**

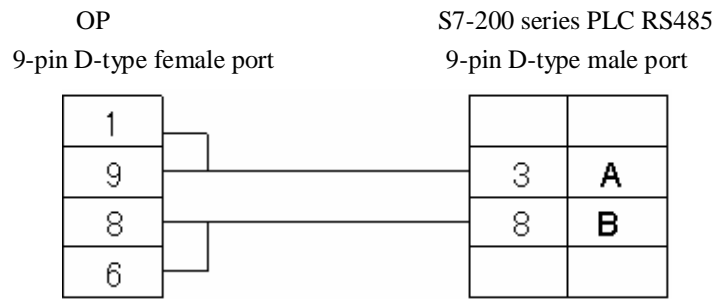

(Diagram 1— fit for OP320-A-S, OP320-S, OP330-S, OP325-S)

**3-4. Omron C series PLC**

OP can communicate with Omron SYSMAC series CJ/CS/CP/CPM/CQM PLC.

**Note:**

1. CPM1A, CQM1-CPU series CPU don't have RS232 port, please configure OMRON CIF01 (RS232) adapter with them. In actual application, please use communication module C500-LK203, C120-LK201-V1, C500-LK201-V1 to finish the RS232 communication.
2. Please choose HostLink protocol in PLC software.
3. PLC start choice please set to MONITOR RUN.

**3-4-1. Connection unit**

Series	CPU	Connected module	Port	Cable	Choose PLC type in OP20
CP	CP1E-30N CP1H CP1L	CPU RS232 port	<b>RS232</b>	Diagram 1	Omron CP/CJ/CS series
		Module CP1W-CIF11	<b>RS485</b>	Diagram 2	
		Module CP1W-CIF11	<b>RS422</b>	Diagram	

				3	
CJ	CJ1G-CPU44 CJ1G-CPU45	CPU RS232 port	<b>RS232</b>	Diagram 1	
CS1	CS1H-CPU63/ 64/65/66/67 CS1G-CPU42/ 43/44/45 CS1G-CPU42H CS1G-CPU43H CS1G-CPU44H CS1G-CPU45H CS1H-CPU63H CS1H-CPU64H CS1H-CPU65H CS1H-CPU66H CS1H-CPU67H	CPU RS232 port	<b>RS232</b>	Diagram 1	
C200	C200HE	CPU RS232 port	<b>RS232</b>	Diagram 1	
CPM	CPM2A CPM2AE CPM2AH-40CDR-A	CPU RS232 port	<b>RS232</b>	Diagram 1	Omron CPM/CQM series
CQM1	CQM1-CPU42				
	CPM1A	OMRON CIF01(RS232) Communication adapter			Omron CP/CJ/CS series
	CQM1-CPU11				
	C1000HF	C500-LK203 (Communication module)	RS232	Diagram 1	
	C2000	C120-LK201-V1 (Communication module)			
		C500-LK201-V1 (Communication module)			
		C500-LK203 (Communication module)			

### 3-4-2. Communication parameters

#### (1) Omron CP/CJ/CS series

##### OP software settings:

Parameters	Recommend settings	Choices of settings	Note
PLC type	Omron CP/CJ/CS series	Omron CP/CJ/CS series Omron CPM/CQM series	Please choose correct PLC type in OP20 software
Port	RS232	RS232	
Data bit	7	7/8	Accord with PLC port parameters
Stop bit	2	1/2	Accord with PLC port parameters
Parity	Even parity	Even /odd/no parity	Accord with PLC port



**2. Module CP1W-CIF11 RS485:**

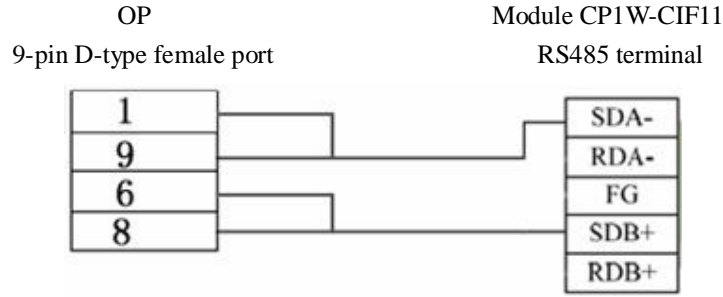

(Diagram 2— fit for OP320-A-S, OP320-S, OP330-S, OP325-S)

**Note: For Omron module CP1W-CIF11, please turn OFF SW1; turn ON SW2, 3, 6; turn ON or OFF SW4.**

**3. Module CP1W-CIF11 RS422:**

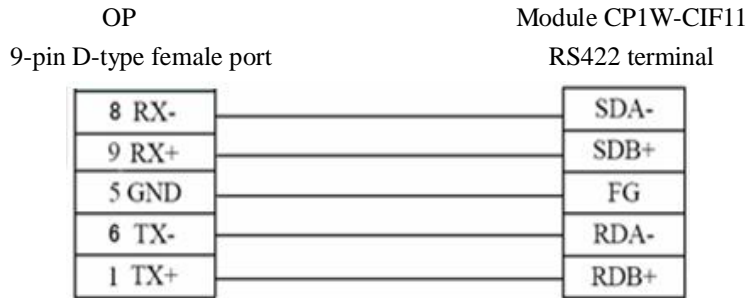

(Diagram 3— fit for: OP320, OP320-A, OP325, OP330)

**Note: For Omron485 module CP1W-CIF11 RS422 connection, please turn OFF SW1~6.**

**3-5. Koyo S series PLC**

**3-5-1. Connection unit**

OP can communicate with Koyo KOSTA-S series, Koyo Direct-Logic series PLC.

**1. Koyo Kostac S series, SH\SM\SN PLC (direct connect to CPU)**

Series	CPU	Connected module	Port	Cable	Choose PLC type in OP20
SH	SH-48RS	CPU	RS232	Diagram 2	Koyo S series

SM	SM24-T				
SN					
SU-6		CPU	<b>RS232</b>	Diagram 1	
SU-6B			<b>RS232</b>	Diagram 1	
			<b>RS422</b>	Diagram 3	

**Note:** Koyo SH-48RS doesn't have Run, Stop switch, but only one port (modular plug)

## 2. Koyo Direct Logic series DL05, DL250 PLC (direct connect to CPU)

Series	CPU	Connected module	Port	Cable	Choose correct PLC in OP20
<b>Direct Logic</b>	DL05 DL105 DL230 DL240 DL250 DL350 DL450	CPU RJ-11 port	<b>RS232</b>	Diagram 2	Koyo S series
	DL250	CPU com port	<b>RS422</b>	Diagram 3	
	DL430 DL440 DL450 DL350	CPU com port	<b>RS232</b>	Diagram 2	

**Note:** DL250 CPU PORT2 has RS232 and RS422, please choose the correct communication cable.

### 3-5-2. Communication parameters

#### OP software settings:

Parameters	Recommend settings	Choices of settings	Notes
PLC type	Koyo S series PLC		Please choose correct PLC type in OP20
Port	RS232	RS232/RS422	
Data bit	8	7/8	Accord with PLC port parameters
Stop bit	1	1/2	Accord with PLC port parameters
Parity	Odd parity	Even /odd /no parity	Accord with PLC port parameters
Baud rate	9600	4800/38400/9600/115200	Accord with PLC port parameters

		/19200/187500	
Station no.	0	0~255	

The default parameters of Koyo S series PLC: 9600, 8, 1, odd parity, station no.0

**PLC software settings:**

1. Choose K protocol, station no.1 in the software.
2. Koyo K protocol doesn't have station no. problem, the communication parameters cannot be changed. It is no need to change the station no. of OP. (OP20 default station no. is 0, it is not need to be changed).
3. The register address starts from R2000 in OP20.

**3-5-3. Cable connection**

**1. CPU or communication unit 25-pin RS232 port**

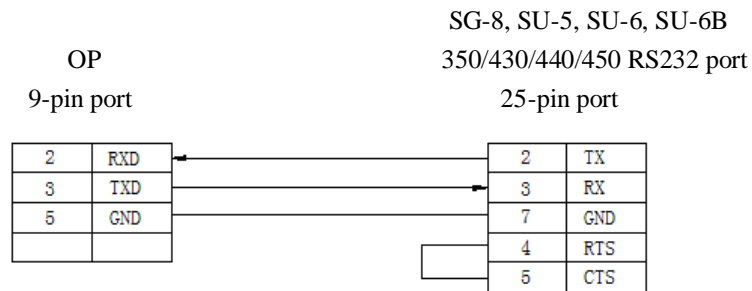

(Diagram 1— fit for OP all series)

**2. CPU 6-pin RJ-11 RS232 port**

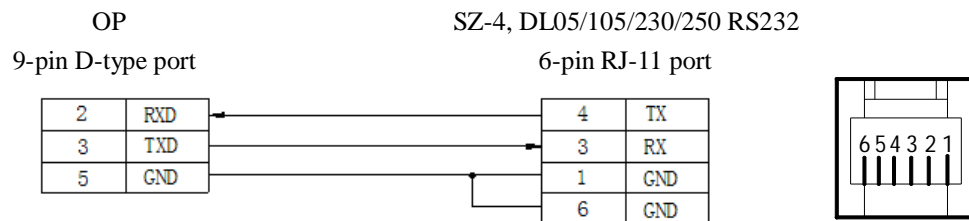

(Diagram 2— fit for OP all series)

### 3. RS422 connection:

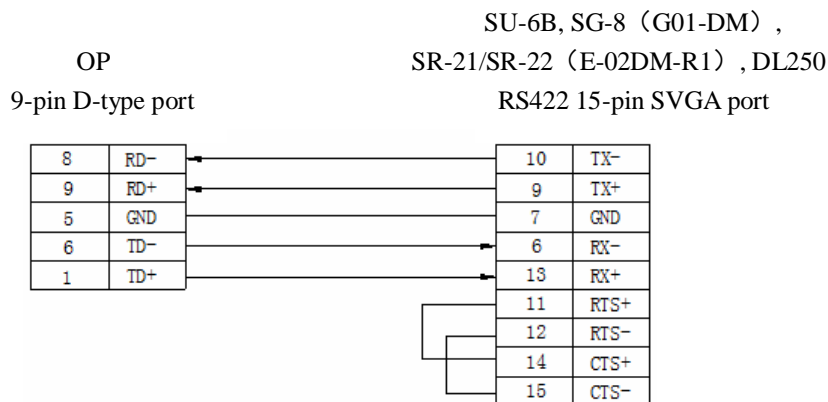

(Diagram 3— fit for OP320, OP320-A, OP325, OP330)

### 3-6. Delta DVP series PLC

#### 3-6-1. Connection unit

OP can communicate with Delta DVP series PLC through PLC programming port.

Series	Connected module	Port	Cable	Choose PLC type in OP20
ES/EH/EX	CPU	RS232	Diagram 1	Delta DVP series
		RS485	Diagram 2	
SS/SA/SC/SX		RS232	Diagram 1	
		RS485	Diagram 2	

#### 3-6-2. Communication parameters

##### OP software settings:

Parameters	Recommend settings	Choices of settings	Notes
PLC type	Delta DVP series PLC		Choose correct PLC type in OP20
Port	RS232	RS232/RS485	
Data bit	7	7/8	Accord with PLC port parameters
Stop bit	1	1/2	Accord with PLC port parameters
Parity	Even parity	Even /odd /no parity	Accord with PLC port parameters
Baud rate	9600	4800/38400/9600/115200/19200/18750	Accord with PLC port parameters

		0	
Station no.	1	0~255	

The default parameters of Delta DVP PLC: 9600, 7, 1, even parity, station no.1

### 3-6-3. Cable connection

#### 1. CPU RS232 port:

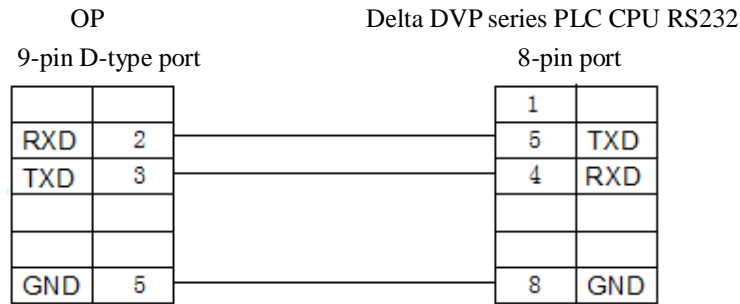

(Diagram 1— fit for OP all series)

#### 2. CPU RS485 port:

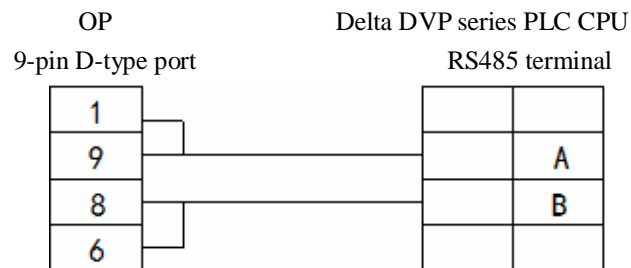

(Diagram 2— fit for OP320-A-S, OP320-S, OP330-S, OP325-S)

### 3-7. LG Master-K (programming port) series PLC

OP can communicate with LG Master-K series PLC.

#### Note:

- (1) OP can communicate with LG PLC through CPU RS232 port or expansion Cnet module.
- (2) Please add END instruction at the end of LG PLC program. Otherwise, the ERR LED will light.

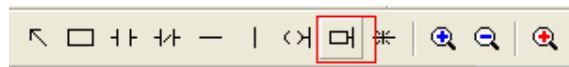

### 3-7-1. Connection unit

Series	Connected module	Port	Cable	Choose
K80 K120	CPU	RS232	Diagram 1	LG Master-K80/120-programming port

### 3-7-2. Communication parameters

#### LG Master-K80/120-programming port, OP software settings

Parameters	Recommend settings	Choices of settings	Notes
PLC type	LG Master-K80/120 Programming port		Choose correct PLC type in OP20
Port	RS232	RS232	
Data bit	8	7/8	Accord with PLC port parameters
Stop bit	1	1/2	Accord with PLC port parameters
Parity	No parity	Even /odd/no parity	Accord with PLC port parameters
Baud rate	38400	4800/38400/9600/115200 /19200/187500	Accord with PLC port parameters
Station no.	0	0~255	

The default parameters of LG Master K PLC programming port: 38400, 8, 1, no parity, station no.0

#### PLC software settings:

The screenshot shows the 'Communication' tab of the PLC software settings. The 'Communication' tab is selected, and the 'Communication' parameter is set to '允许' (allow). The 'Communication mode' is set to 'Station no. 0'. The 'Baud rate' is set to '38400', the 'Data bit' is set to '8', and the 'Stop bit' is set to '1'. The 'Parity' is set to '无校验' (no parity). The 'Communication channel' is set to 'RS232C 无调制解调器或 RS422/485' (RS232C no modem or RS422/485). The 'Initialization command' is set to 'ATZ'.

Annotations in the image point to the following settings:

- Communication: permit
- station no.0 baud rate 38400 no parity data bit: 8 stop bit: 1
- RS232C no modem or RS422/485

### 3-7-3. Cable connection

#### CPU RS232 port:

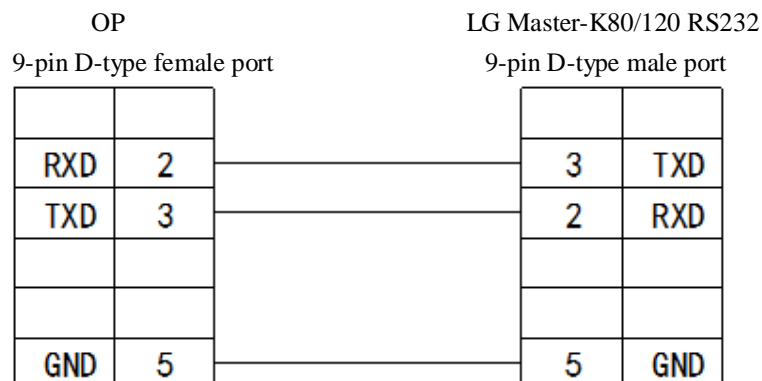

(Diagram 1— fit for OP all series)

### 3-8. LG Master-K (Modbus) series PLC (multi-function port)

#### 3-8-1. Connection unit

##### Connect through Modbus Rtu protocol

Series	Connected module	Port	Cable	Choose PLC type in OP20
K80 K120	Modbus Rtu protocol	<b>RS232</b>	Diagram 1	LG Master-K80/120S multi-function port (Modbus)

**Note:** For LG Master K-Modbus Rtu, please turn ON switch 2 and turn OFF switch 1. (it is no need to change the switch for LG Master KxxxS programming port).

#### 3-8-2. Communication parameters

##### LG Master-K80/120 (Modbus Rtu) series PLC OP software settings:

Parameters	Recommend settings	Choices of settings	Notes
PLC type	LG Master-K80/120 Multi-function port (Modbus Rtu)		Choose the correct PLC type in OP20
Port	RS232	RS232	
Data bit	8	7/8	Accord with PLC port parameters
Stop bit	1	1/2	Accord with PLC port parameters
Parity	Even parity	Even /odd /no parity	Accord with PLC port parameters
Baud rate	9600	4800/38400/9600/ 115200/19200/187500	Accord with PLC port parameters

Station no.	1	0~255	
-------------	---	-------	--

The default parameters of LG Master K-Modbus : 9600, 8, 1, even parity, station no.1

**PLC settings:**

- Note:** (1) Turn on PLC switch BUILT-IN CNET  
 (2) Please choose Modbus Slave protocol

**RS232 communication**



Modbus: slave  
 Transmission mode: RTU(Hex)

**3-8-3. Cable connection**

**1. LG Modbus Rtu RS232:**

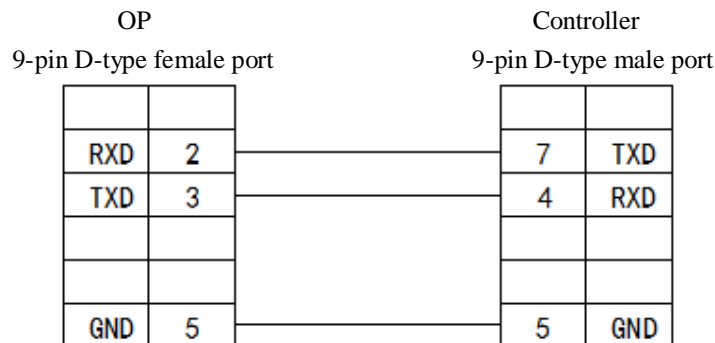

(fit for : OP all series)

## 2. LG Modbus Rtu RS485:

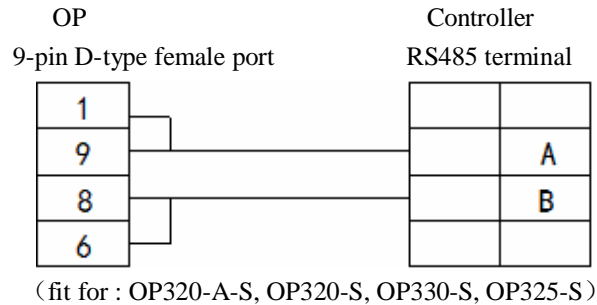

## 3-9. LG Master-K (Cnet) series PLC (multi-function port)

### 3-9-1. Connection unit

Expansion Cnet module:

Series	Connected module	Port	Cable	Choose PLC type in OP20
K80 K120	Cnet	RS232	Diagram 1	LG Master-K80/120S multi-function port (Cnet)
		RS485	Diagram 2	

**Note:**

- (1) For LG Master K-cnet, please turn ON switch 2 and turn off switch 1. (It is no need to change the switch of LG Master KxxxS)
- (2) LG Master KxxxS programming port cannot support RS485. Cnet can support RS485.

### 3-9-2. Communication parameters

LGMaster-K80/120 (Cnet) PLC OP software settings

Parameters	Recommend settings	Choices of settings	Notes
PLC type	LG Master-K80/120 Multi-function port (Cnet)		Choose the correct PLC type in OP20
Port	RS232	RS232	
Data bit	8	7/8	Accord with PLC port parameters
Stop bit	1	1/2	Accord with PLC port parameters
Parity	No parity	Even /odd/no parity	Accord with PLC port parameters
Baud rate	19200	4800/38400/9600/115200 /19200/187500	Accord with PLC port parameters
Station no.	1	0~255	



### 3-9-3. Cable connection

#### 1. CPU (or expansion Cnet module)

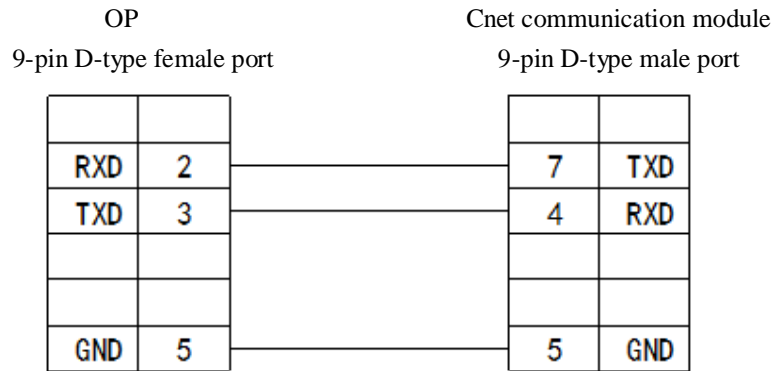

(Diagram 1— fit for OP all series)

- Note:** (1) Turn ON switch BUILT-IN CNET of PLC.  
 (2) Choose CNet port when making new PLC program.

#### 2. RS485 connection:

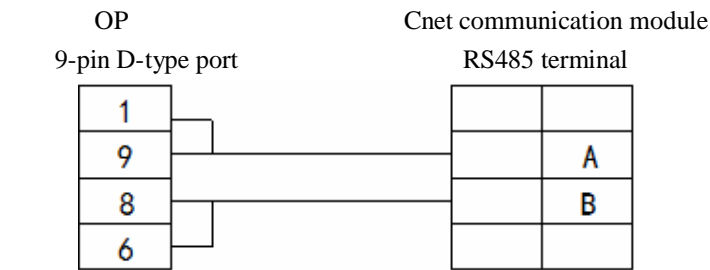

(Diagram 2— fit for OP320-A-S, OP320-S, OP330-S, OP325-S)

### 3-10. Matsushita FP series PLC

OP can communicate with Matsushita FP series PLC through programming port or expansion port.

#### 3-10-1. Connection unit

Series	CPU	Connected module	Port	Cable	Choose PLC type in OP20
FP	FP0	CPU	<b>RS232</b>	Diagram 1	Matsushita FP0/FP1 series
	FP-M	CPU	<b>RS232</b>	Diagram 1	
	FP-X	CPU	<b>RS232</b>	Diagram 1	
	FPΣ	CPU	<b>RS232</b>	Diagram 1	
	FP2	CPU	<b>RS232</b>	Diagram 1	
		CPU RS232	<b>RS232</b>	Diagram 2	
	FP2SH	CPU	<b>RS232</b>	Diagram 1	
		CPU RS232	<b>RS232</b>	Diagram 2	
	FP1	CPU RS232	<b>RS232</b>	Diagram 2	
		CPU RS232	<b>RS422</b>	Diagram 3	
	FP3	CPU RS232	<b>RS422</b>	Diagram 4	
FP10SH FP10S	CPU RS232	<b>RS232</b>	Diagram 2		
FP-e	CPU	<b>RS232</b>	Diagram 1		

**Note:** Only FP0-CXXCXX has RS232 port.

#### 3-10-2. Communication parameters

##### OP software settings

Parameters	Recommend settings	Choices of settings	Note
PLC type	Matsushita (FP1/FP0)		Choose the correct PLC type in OP20
Port	RS232		
Data bit	8	7/8	Accord with PLC port parameters
Stop bit	1	1/2	Accord with PLC port parameters
Parity	Odd parity	Even /odd /no parity	Accord with PLC port parameters
Baud rate	9600	4800/38400/9600/ 115200/19200/187500	Accord with PLC port parameters
Station no.	1	0~255	

The default parameters of Matsushita FP series PLC: 9600, 8, 1, odd parity, station no.1

## PLC settings



Programming port settings

No. 410 station no.1  
No. 412 Communication mode:  
PC connection

### Note:

- (1) Please set the PLC register like this in OP software:

PLC	OP
R45	R 4 . 5

- (2) Make sure the PLC switch is turn to PPOG
- (3) The PLC must RUN when communicating with OP.
- (4) Do not choose general communication mode when setting the PLC parameters, otherwise, the communication will be error.
- (5) FP series PLC station no. is 1, but FP3 must be no.0.

### 3-10-3. Cable connection

#### 1. CPU RS232 port:

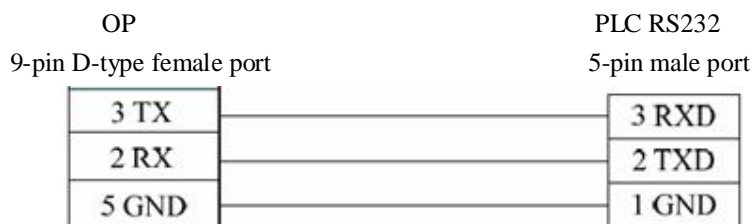

(Diagram 1— fit for OP all series)

**2. CPU RS232:**

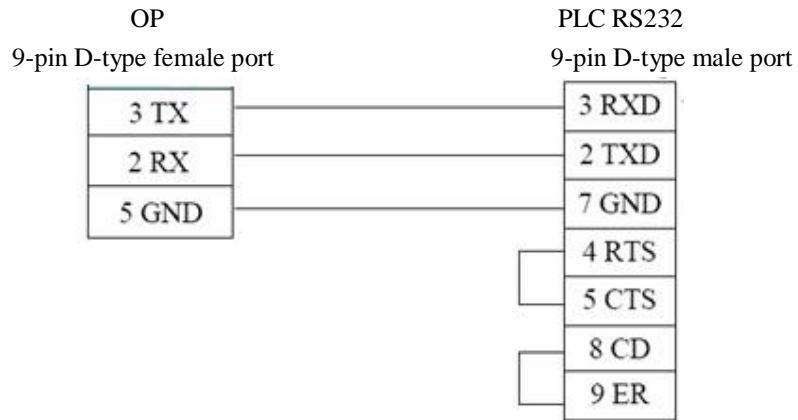

(Diagram 2— fit for OP all series)

**3. CPU RS422:**

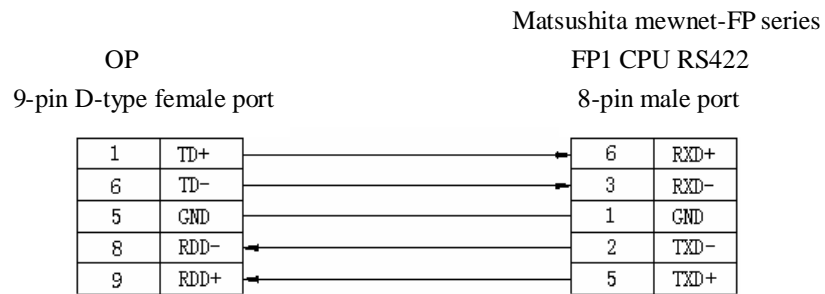

(Diagram 3— fit for OP320, OP320-A, OP325, OP330)

**4. CPU 15-pin port:**

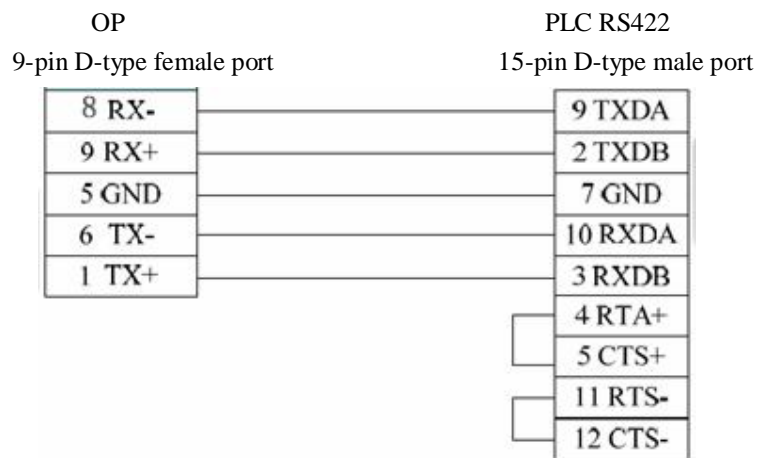

(Diagram 4— fit for OP320, OP320-A, OP325, OP330)

### 3-11. Schneider NEZA series PLC

OP can communicate with Schneider NEZA PLC through programming port. (Modbus protocol)

#### 3-11-1. Connection unit

Series	CPU	Connected module	Port	Cable	Choose PLC type in OP20
Micro	TSX 37-05 TSX 37-08 TSX 37-10 TSX 37-21/22	CPU	RS485	Diagram 1	Schneider Micro/NEZA/Twido Series PLC
Twido	Twido CPU	CPU	RS485	Diagram 1	
M	M218/M238 /M258	CPU	RS485	Diagram 2	
NEZA	TSX07 CPU	CPU	RS485	Diagram 1	

#### 3-11-2. Communication parameters

##### OP software settings

Parameters	Recommend settings	Choices of settings	Notes
PLC type	Schneider Micro/ NEZA/ Twido series PLC		Choose the correct PLC type in OP20
Port	RS485		
Data bit	8	7/8	Accord with PLC port parameters
Stop bit	1	1/2	Accord with PLC port parameters
Parity	Even parity	Even /odd /no parity	Accord with PLC port parameters
Baud rate	19200	4800/38400/9600 /115200/19200/187500	Accord with PLC port parameters
Station no.	1	0~255	

Schneider Micro/NEZA/ Twido series PLC: 19200, 8, 1, even parity, station no.1

**PLC software settings:**

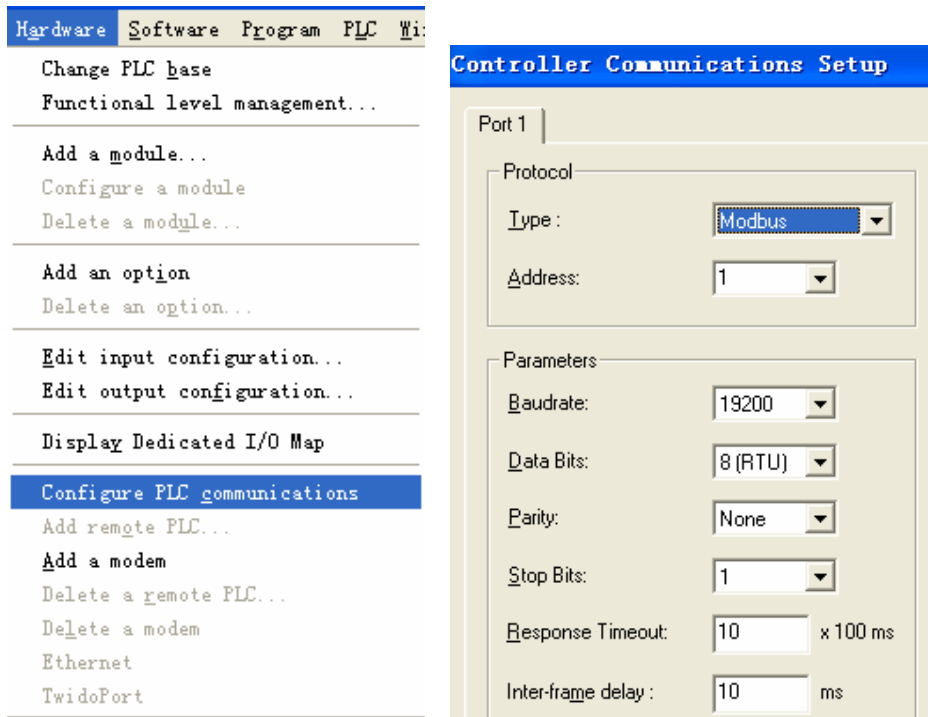

**Note:** 1. The register of Twido is dynamic managed. Please add a sentence at the end of PLC program to avoid communication error.

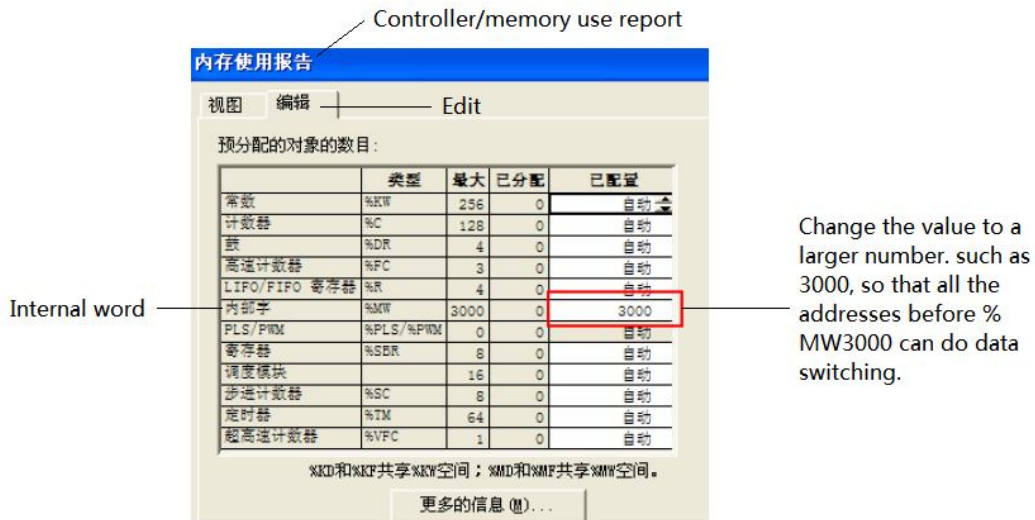

2. To open the bit address range, you have to make a program as below. For example: drive a coil of %M127, all the addresses before %M127 can do data switching.



### 3-11-3. Cable connection

#### 1. CPU RS485:

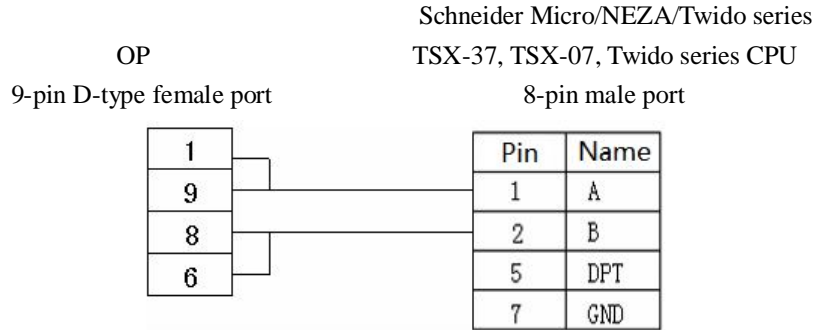

(Diagram 1— fit for OP320-A-S, OP320-S, OP330-S, OP325-S)

#### 2. M238 CPU:

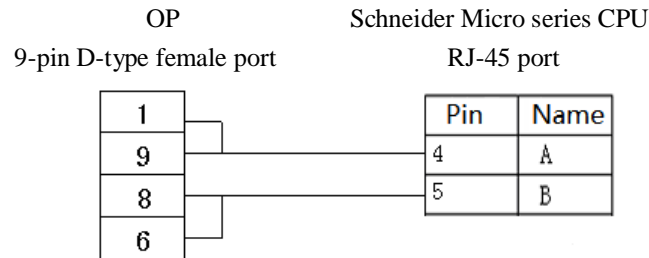

(Diagram 2— fit for OP320-A-S, OP320-S, OP330-S, OP325-S)

### 3-12. Fatek FB series PLC

OP can communicate with Fatek FB series PLC through programming port or com port.

#### 3-12-1. Connection unit

Series	CPU	Connected module	Port	Cable	Choose
FBs	FBs-20MN FBs-32MN FBs-44MN	CPU	RS232	Diagram 1	Fatek MU/MA series PLC
			RS485	Diagram 2	
FB -MC	20MC/28MC 40MC/19MCT		RS232	Diagram 1	

	26MCT/36MCT		<b>RS485</b>	Diagram 2	
FB -MA	20MA 28MA 40MA	FB-DTBR/ DTBR-E module	<b>RS232</b>	Diagram 3	
			<b>RS232</b>	Diagram 4	
			<b>RS485</b>	Diagram 5	

**Note:** For MA series CPU, please transform the com port to RS232 or RS485 through FB-DTBR or FB-DTBR-E module.

### 3-12-2. Communication parameters

#### OP software settings

Parameters	Recommend settings	Choices of settings	Notes
PLC type	Fatek MU/MA Series PLC		Choose the correct PLC type in OP20
Port	RS232	RS232/RS485	
Data bit	7	7/8	Accord with PLC port parameters
Stop bit	1	1/2	Accord with PLC port parameters
Parity	Even parity	Even /odd /no parity	Accord with PLC port parameters
Baud rate	9600	4800/38400/9600/115200 /19200/187500	Accord with PLC port parameters
Station no.	1	0~255	

The default parameters of Fatek MU/MA series PLC: 9600, 7, 1, even parity, station no.1

### 3-12-3. Cable connection

#### 1. CPU RS232:



(Diagram 1— fit for OP all series)

**CPU port:**

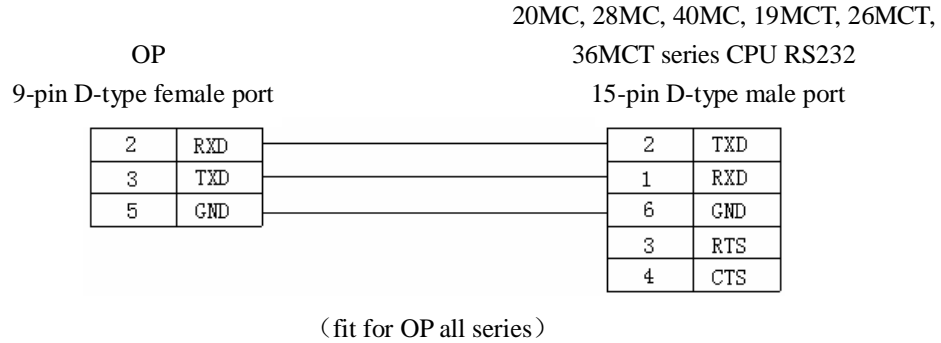

**2. CPU RS485:**

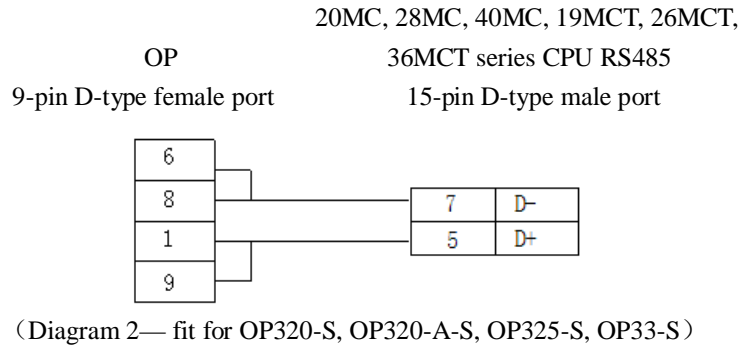

**3. FB-DTBR/DTBR-E module RS232:**

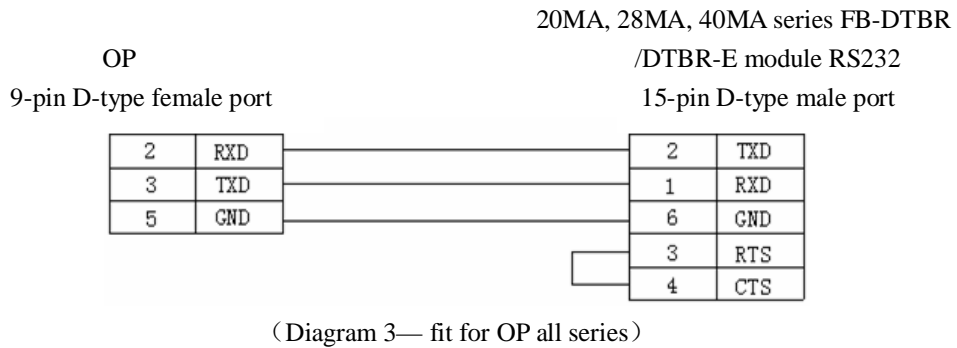

#### 4. FB-DTBR/DTBR-E RS232:

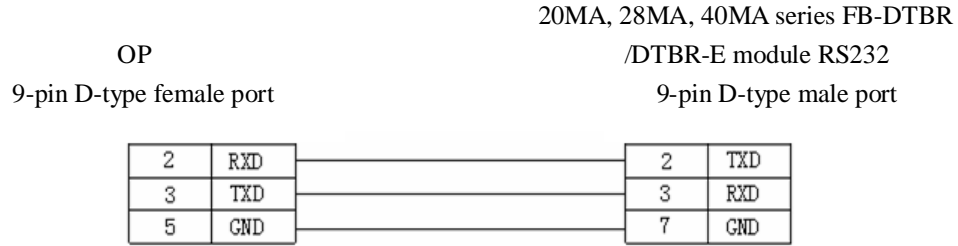

(Diagram 4 — fit for OP all series)

#### 5. FB-DTBR/DTBR-E RS485:

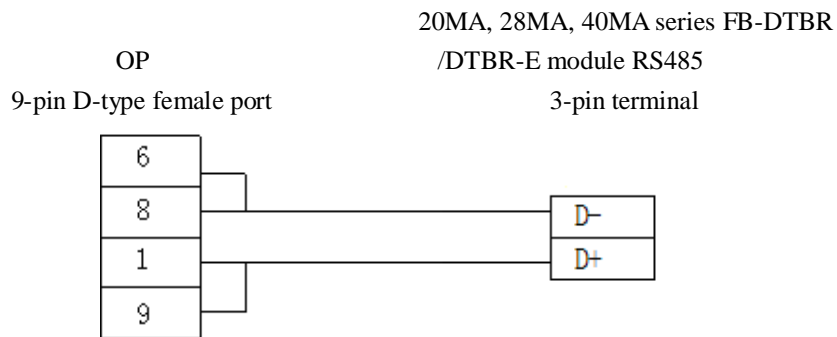

(Diagram 5 — fit for OP320-S, OP320-A-S, OP325-S, OP33-S)

### 3-13. Vigor VB series PLC

OP can communicate with Vigor VB series PLC (including VB0, VB1, VB2) through CPU programming port.

#### 3-13-1. Connection unit

Series	CPU	Connected module	Port	Cable	Choose PLC type in OP20
VB	VB0-14M VB0-20M VB0-28M VB0-32M VB1-14MT-D VB1-24MT-D VB1-32MTMT-D	CPU	<b>RS232</b>	Diagram 1	Vigor VB series PLC
		Expansion card	<b>RS232</b>	Diagram 2	
			<b>RS422</b>	Diagram 3	

	VB2-16M VB2-32M		<b>RS485</b>	Diagram 4
VH	VH -14MR	CPU	<b>RS232</b>	Diagram 1

### 3-13-2. Communication parameters

#### OP software settings

Parameters	Recommend settings	Choices of settings	Note
PLC type	Vigor VB series PLC		Choose correct PLC type in OP20
Port	RS232	RS232/RS485/RS422	
Data bit	7	7/8	Accord with PLC port parameters
Stop bit	1	1/2	Accord with PLC port parameters
Parity	Even parity	Even /odd / no parity	Accord with PLC port parameters
Baud rate	19200	4800/38400/9600/ 115200/19200/187500	Accord with PLC port parameters
Station no.	0	0~255	

The default parameters of Vigor VB series PLC: 19200, 7, 1, even parity, station no.0

### 3-13-3. Cable connection

#### 1. CPU RS232-A USB connector:

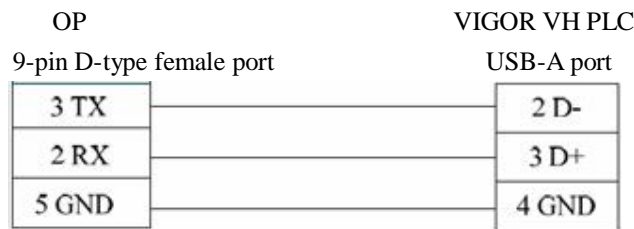

(Diagram 1— fit for OP all series)

#### 2. CPU RS232 expansion card:

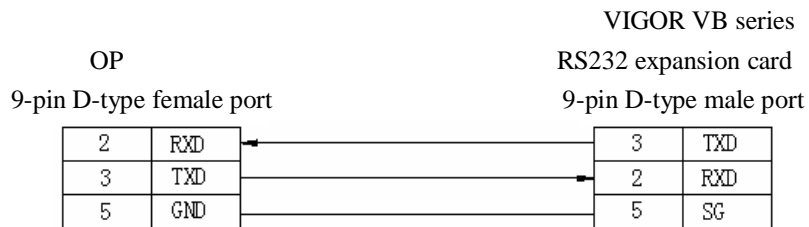

(Diagram 2— fit for OP all series)

### 3. CPU RS485 expansion card:

#### (1) RS422 connection

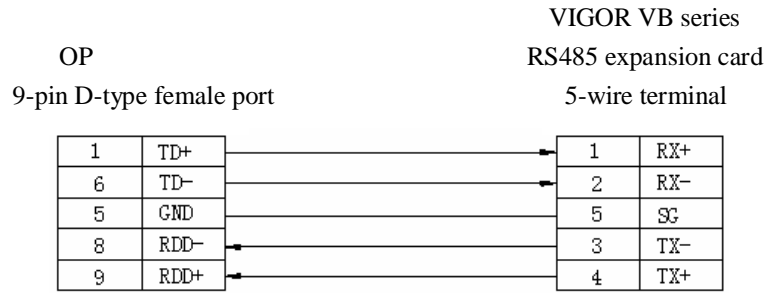

(Diagram 3— fit for OP320, OP320-A, OP325, OP330)

#### (2) RS485 connection

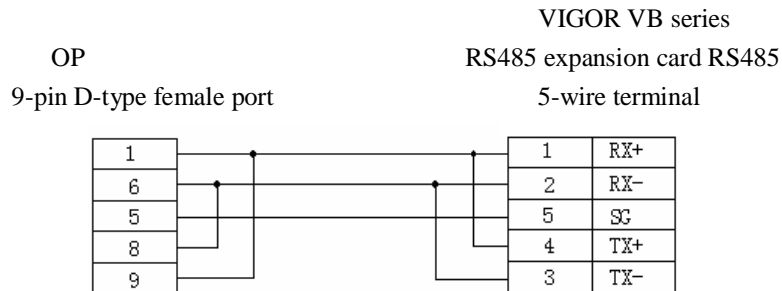

(Diagram 4 — fit for OP320-S, OP320-A-S, OP325-S, OP33-S)

## 3-14. Emerson EC20 series PLC

### 3-14-1. Connected unit

Series	CPU	Connected module	Port	Cable	Choose PLC type in OP20
EC20	EC20	COM0	RS232	Diagram1	Emerson EC20 series PLC
		COM1	RS485	Diagram2	
			RS232	Diagram3	

### 3-14-2. Communication parameters

#### OP software settings

Parameters	Recommend settings	Choices of settings	Note
PLC type	Emerson EC20 series PLC		Choose correct PLC type in OP20
Port	RS232	RS232/RS485	
Data bit	8	7/8	Accord with PLC port parameters
Stop bit	1	1/2	Accord with PLC port parameters
Parity	Even parity	Even / odd / no parity	Accord with PLC port parameters
Baud rate	9600	4800/38400/9600/ 115200/19200/187500	Accord with PLC port parameters
Station no.	1	0~255	

Emerson EC20 series PLC: 9600, 8, 1, even parity, station no.1

### 3-14-3. Cable connection

#### 1. Emerson EC20 PLC COM0 (RS232):

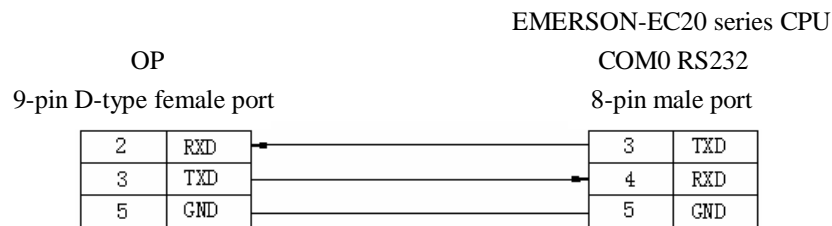

(Diagram 1— fit for OP all series)

#### 2. Emerson EC20 series PLC COM1 (RS232):

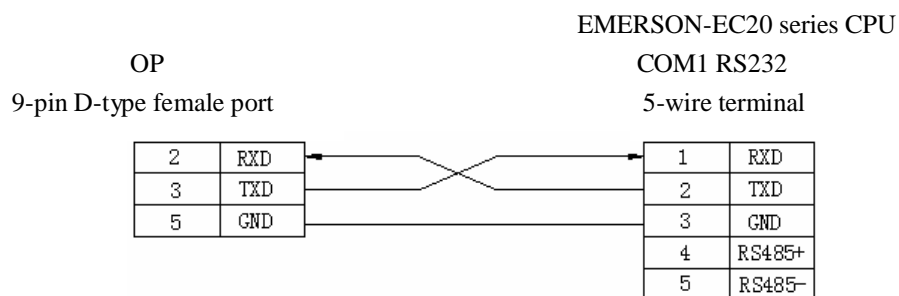

(Diagram 2— fit for OP all series)

### 3. Emerson EC20 series PLC COM1 (RS485) :

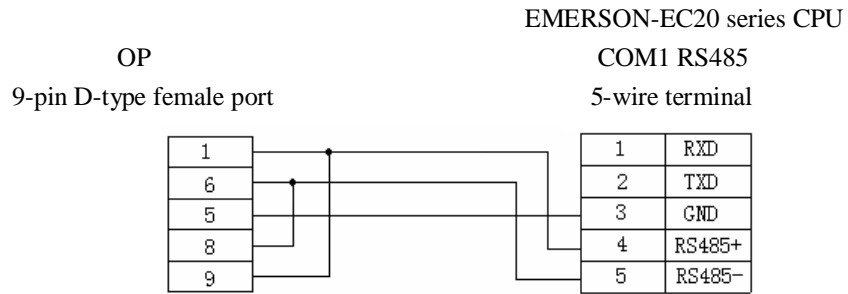

(Diagram 3— fit for OP320-S, OP320-A-S, OP325-S, OP33-S)

**Note:** Emerson EC20 series PLC COM1 has RS232 and RS485. Only one of them can be used at the same time. Do not connect unused com to avoid interference.

### 3-15. IDEC Micro Smart series PLC

#### 1. IDEC CPU (Micro3 series) RS485:

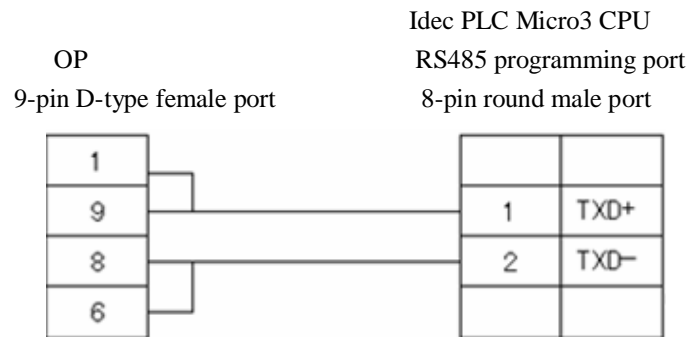

(fit for OP320-A-S, OP320-S, OP330-S, OP325-S)

**2. IDEC CPU (Micro3C series) RS232:**

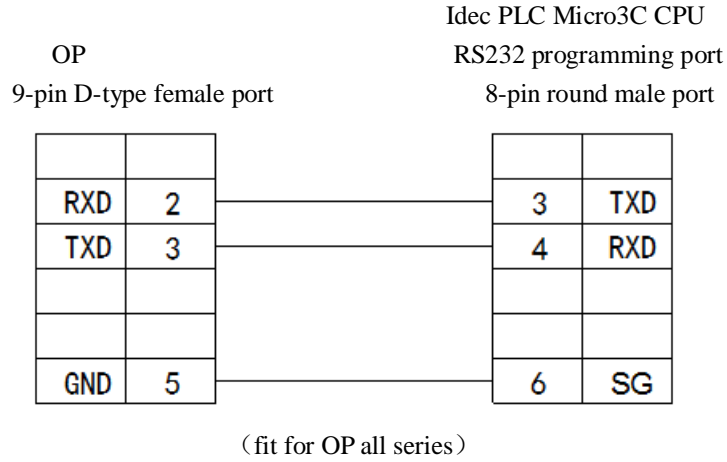

**3-16. Keyence KV series PLC**

**Keyence KV series PLC CPU RS232 port:**

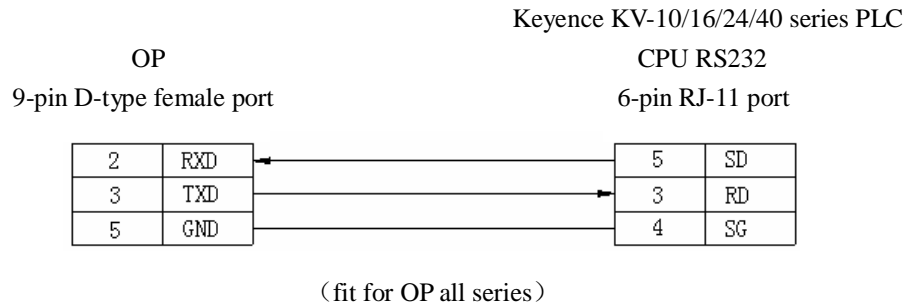

**PLC RJ-11 port:**

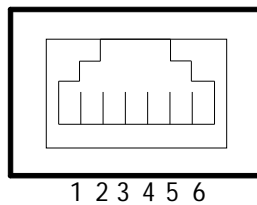

### 3-17. SAIA-Burgess PCD series PLC

#### SAIA-Burgess PCD series PLC RS232 port:

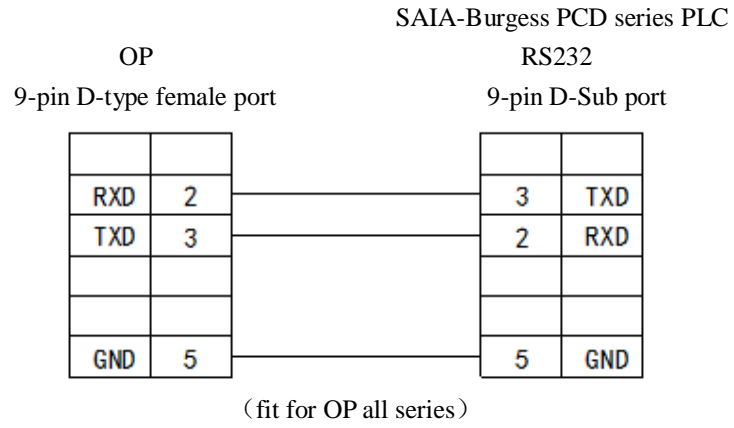

**XINJE**

**XINJE Electric Co., Ltd.**

4th Floor, Building 7th, No.100

Dicui Rd, Wuxi, China

Tel: 86-0510-85134139

Fax: 86-0510-85111290

[www.xinje.com](http://www.xinje.com)

Email: [cheerfiona@gmail.com](mailto:cheerfiona@gmail.com)